

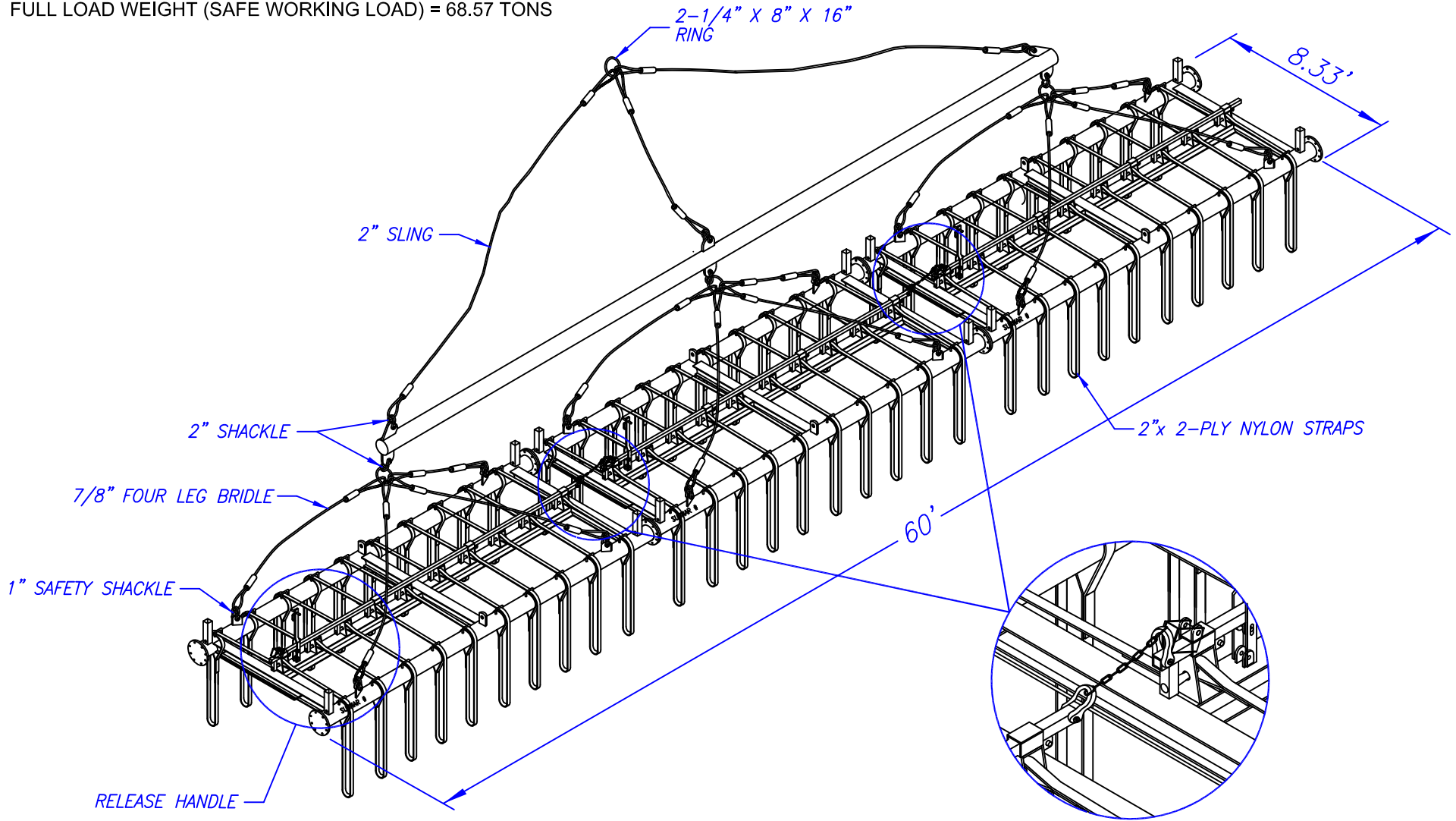

(DEPENDING ON MAT CONFIGURATION)  
 TOTAL HOOK HEIGHT WITH MAT = 43' OR 51'  
 FRAME LOAD CAPACITY (WEIGHT OF MATS) = 60.57 TONS  
 FRAME EMPTY WEIGHT = 8.00 TONS  
 FULL LOAD WEIGHT (SAFE WORKING LOAD) = 68.57 TONS



<p>805 Dunn Street          Houma, LA 70360          Ph. 985-868-0001          Fax 985-851-0108          Email: <a href="mailto:submar@submar.com">submar@submar.com</a>          Website: <a href="http://www.submar.com">www.submar.com</a></p> 	<p>SHEET TITLE:  <b>60' Single Release Deployment Frame</b></p>						
<p>THESE CONCEPTUAL DRAWINGS ARE PREPARED BY SUBMAR FOR ESTIMATING PURPOSES ONLY AND ARE NOT CONSTRUCTION DRAWINGS. THESE CONFIDENTIAL DRAWINGS MAY NOT BE COPIED UNLESS APPROVED BY SUBMAR, INC.</p>	<table border="1"> <tr> <td data-bbox="514 1502 735 1550">COPYRIGHT © SUBMAR, INC. 2011 ALL RIGHTS RESERVED.</td> <td data-bbox="735 1502 850 1550">DATE: 04/27/11</td> <td data-bbox="850 1502 955 1550">SHEET: 1 of 1</td> <td data-bbox="955 1502 1060 1550">SCALE: N.T.S.</td> <td data-bbox="1060 1502 1165 1550">PROJECT #</td> <td data-bbox="1165 1502 1291 1550">DRAWING #</td> </tr> </table>	COPYRIGHT © SUBMAR, INC. 2011 ALL RIGHTS RESERVED.	DATE: 04/27/11	SHEET: 1 of 1	SCALE: N.T.S.	PROJECT #	DRAWING #
COPYRIGHT © SUBMAR, INC. 2011 ALL RIGHTS RESERVED.	DATE: 04/27/11	SHEET: 1 of 1	SCALE: N.T.S.	PROJECT #	DRAWING #		

PATENTED  
 NO. 6,139,220  
 NO. 6,106,194